Ten Years of Performance Evaluation for Concurrent Systems using CADP

Nicolas Coste¹ Hubert Garavel² Holger Hermanns^{2,3}
Frédéric Lang² Radu Mateescu² Wendelin Serwe²

¹ STMicroelectronics, Grenoble, France

² VASY (INRIA and LIG, Grenoble, France)

³ Saarland University, Saarbrücken, Germany



What is CADP?

A toolbox for analyzing asynchronous systems

- At the crossroads between four computer-science branches:
 - Formal methods
 - Concurrency theory
 - Computer-aided verification
 - Performance evaluation
- Development started in 1986:
 - Initially, there were only 2 tools (Caesar and Aldebaran)
- Today (CADP 2010):
 - 45 tools
 - 22 code libraries

CADP 2010

- A large functionality spectrum:
 - Several specification languages
 - Code generation, rapid prototyping
 - Explicit-state verification
 - Step-by-step, random, ... simulation
 - Test generation
 - Performance evaluation (since 2000)

- Architectural principles:
 - Generic software components
 - Modular, extensible architecture

Performance evaluation in CADP 2010

- Answer to *quantitative questions* such as:
 - Is the system efficient? (*performance estimation*)
 - Which probability for a failure? (*dependability*)
- Use *extended Markovian models* combining
 - Functional models specified in high-level languages (e.g. the LOTOS [ISO-88] and LOTOS NT languages for describing protocols and distributed systems)
 - Performance data based on (discrete and continuous time) Markov chains

The initial picture

functional verification

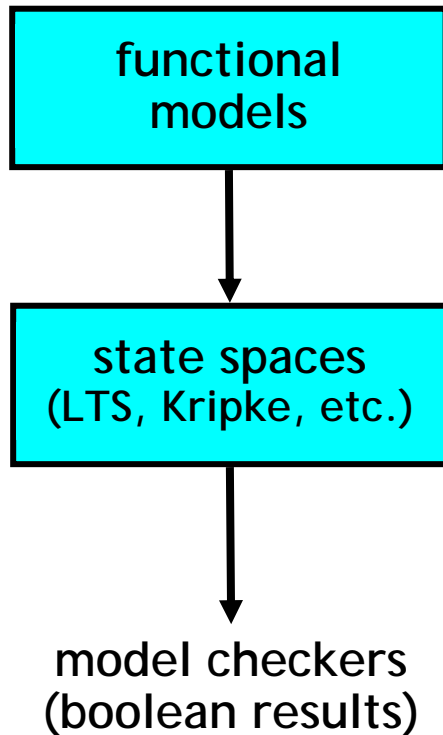

performance evaluation

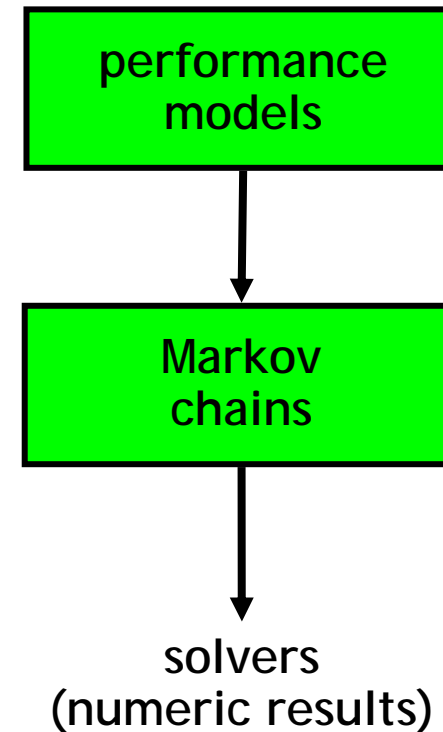

Extended Markovian models (1/2)

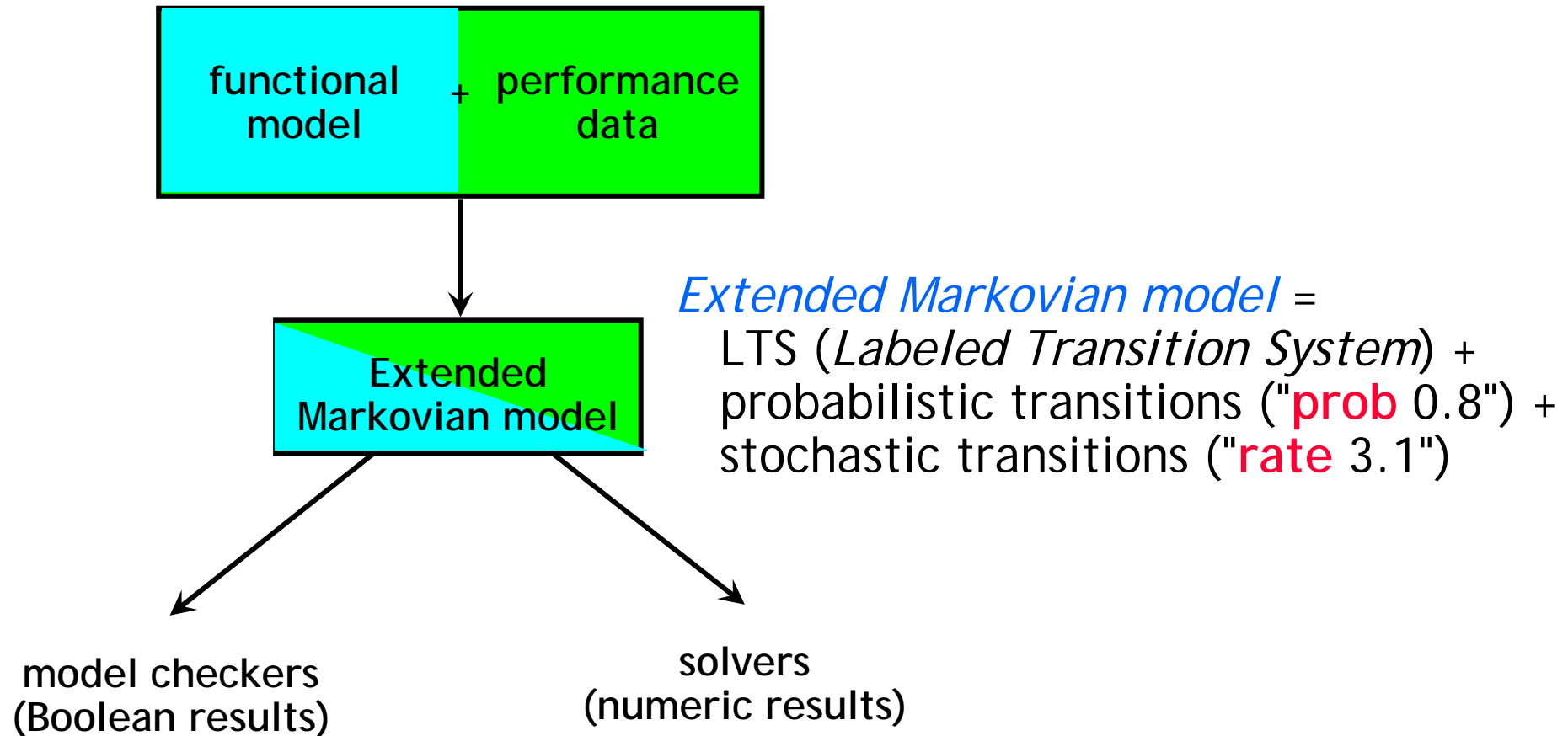

Extended Markovian models (2/2)

Model	LTS transitions	Stochastic transitions	Probabilistic transitions
LTS (<i>Labeled Transition System</i>)	✓	✗	✗
CTMC (<i>Continuous Time Markov Chain</i>)	✗	✓	✗
DTMC (<i>Discrete Time Markov Chain</i>)	✗	✗	✓
IMC (<i>Interactive Markov Chain</i>) [Hermanns 99]	✓	✓	✗
IPC (<i>Interactive Probabilistic Chain</i>) [Coste 10]	✓	✗	✓
Extended Markovian models [CADP]	✓	✓	✓

Models subsumed by CADP's extended Markovian models (among others)

Two approaches for performance evaluation

- Approach #1:

- Generation of a Markovian model
- Analysis using a Markovian solver

State explosion sometimes occurs

- Approach #2:

- Random simulation and on-the-fly analysis

CADP tools for Markovian model generation

The BCG format and library

- A file format for storing huge state/transition models (up to 2^{44} explicit states)
- A set of tools for handling BCG files: format conversions, LTS info, visualization, hiding, renaming, ...
- Five kinds of transitions
 - *ordinary transitions* a
 - *stochastic transitions* "rate r " ($r \in \mathbb{R}^+$)
 - *labeled stochastic transitions* " a ; rate r " ($r \in \mathbb{R}^+$)
 - *probabilistic transitions* "prob p " ($p \in]0, 1]$)
 - *labeled probabilistic transitions* " a ; prob p " ($p \in]0, 1]$)

High-level specifications

- Functional model specified in LOTOS or LOTOS NT
- Two ways to model performance aspects
 - Model rates symbolically using ordinary labels, later on instantiated (i.e., renamed) with actual values
 - Or use constraint-oriented specification style, a safe and compositional technique to insert delays in a functional specification

Example: insert between successive actions A and B a delay represented by the red CTMC

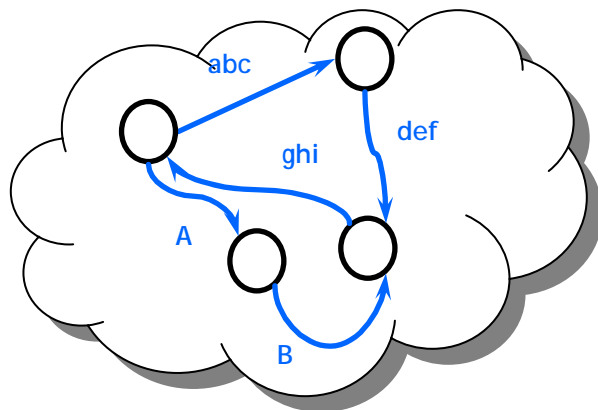

| [A, B] |

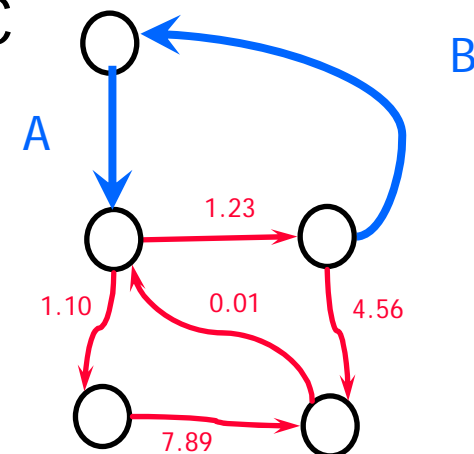

The CAESAR.ADT and CAESAR tools

- Compilers for **LOTOS**
- **CAESAR.ADT**: a compiler for LOTOS data types
 - generates C code (compiles pattern-matching)
 - optimizes both memory and time
- **CAESAR**: a compiler for LOTOS processes
 - translates LOTOS into Petri nets, then into LTS
 - generates C code for on-the-fly state exploration

Connections with other languages

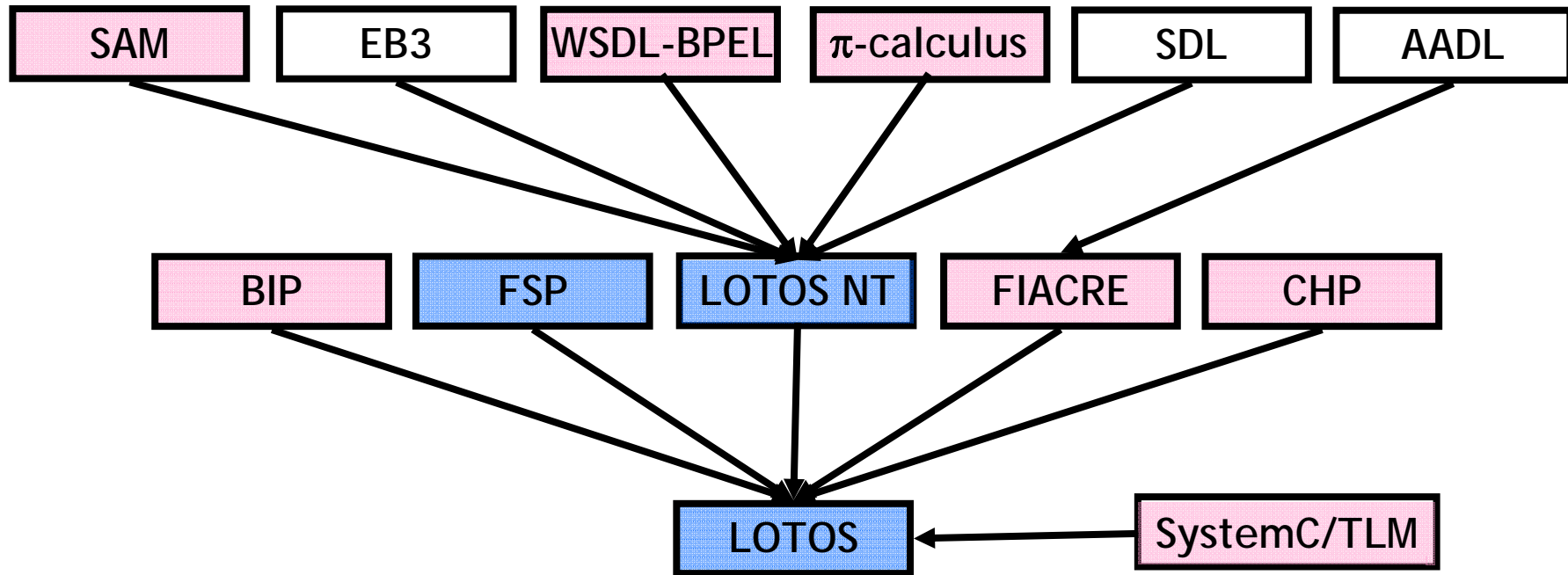

Blue = available in CADP 2010

Pink = separate prototypes

The EXP.OPEN 2.0 tool

- **EXP**: a small language for describing networks of communicating automata
 - parallel composition operators (LOTOS, CCS, CSP, mCRL, etc.) or synchronization vectors
 - label hiding, renaming, cutting using regexps
 - "priority" operator
- **EXP.OPEN**: a state space generator for EXP
 - on the fly partial order reductions (branching eq., weak trace eq., stochastic/probabilistic eq.)
- Generates parallel composition of extended Markovian models
- No synchronization on "rate"/"prob" transitions

The BCG_MIN 2.0 tool

- An efficient minimization tool
 - **Inputs:** BCG graph
Chosen equivalence for minimization
 - **Output:** Minimized BCG graph
- Strong and branching bisimulations + lumpability

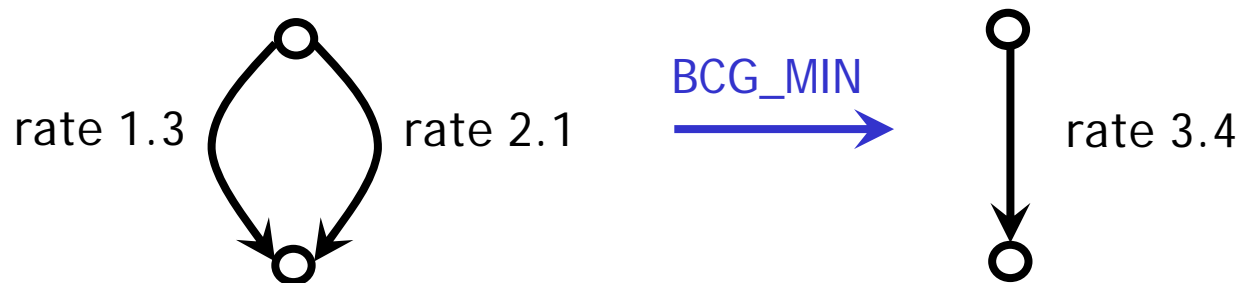

- Recent improvements (for Markovian models)
 - 500 times faster and 4 times less memory than previous version 1.0
 - Input graph up to 10^7 states and 10^8 transitions

The DETERMINATOR tool

- On-the-fly generation of a Markov Chain
 - Applies local transformations to remove stochastic nondeterminism
 - Implements a determinacy check ("well specified" stochastic process)
 - Algorithm is a variant of [Deavours-Sanders-99]
- **Input:** On-the-fly extended Markovian model
- **Output:** BCG graph (extended CTMC) or error message

CADP tools for numerical analysis of extended Markovian models

The BCG_TRANSIENT tool

- Numerical solver for Markov chains
- Transient analysis
- **Inputs:**
 - Extended Markovian model in the BCG format
 - List of time instants
- **Outputs:**
 - Numerical data usable by Excel, Gnuplot...
- **Method:**
 - BCG graph converted into a sparse matrix
 - Uniformisation method to compute Poisson probabilities
 - *Fox-Glynn* algorithm [Stewart94]

The BCG_STEADY tool

- Numerical solver for Markov chains
- Steady-state analysis (equilibrium)
- **Inputs:**
 - Extended Markovian model in the BCG format
 - No deadlock allowed
- **Outputs:**
 - Numerical data usable by Excel, Gnuplot...
- **Method:**
 - BCG graph converted into a sparse matrix
 - Computation of a probabilistic vector solution
 - Iterative algorithm using *Gauss-Seidel* [Stewart94]

CADP tool for on-the-fly Markovian model simulation

The CUNCTATOR tool

- A steady-state random simulator for IMCs
- On-the-fly label hiding and renaming to produce a (labeled) CTMC with internal actions
- On-the-fly exploration of a sequence:

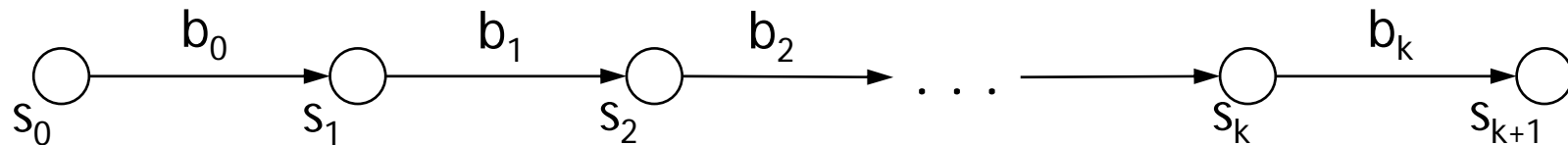

- Compute the throughput of each stochastic action " a ; rate r "
- Different scheduling strategies for internal actions
- Save/restore context of simulation
- Caching of internal sequences of transitions

Additional tools for Interactive Probabilistic Chains

IPC (*Interactive Probabilistic Chains*)

- Extended Markovian model [Coste, PhD 10]:
 - Ordinary transitions
 - Probabilistic transitions that take one time step
- Three prototype tools:
 - **IPC_COMPOSE**: parallel composition of IPC represented as BCG files
 - Synchronized probabilistic transitions "**prob** p " and "**prob** q " yield "**prob** $p \times q$ "
 - **IPC_INSERT**: insertion of delays in an IPC
 - **IPC_DISTRIBUTION**: computes the steady-state probability distribution of the latency between two actions a and b

Real-life applications

- Hubble telescope lifetime
[Hermanns, EATCS 01]
- SCSI-2 bus arbitration protocol
[Garavel & Hermanns, FM 02]
- MPI send/receive & barrier primitives
[Chehaibar & Zidouni & Mateescu, Quest 09]
- XStream data-flow architecture
[Coste et al., CAV 09]
- Mutual exclusion protocols
[Mateescu & Serwe, FMICS 10]

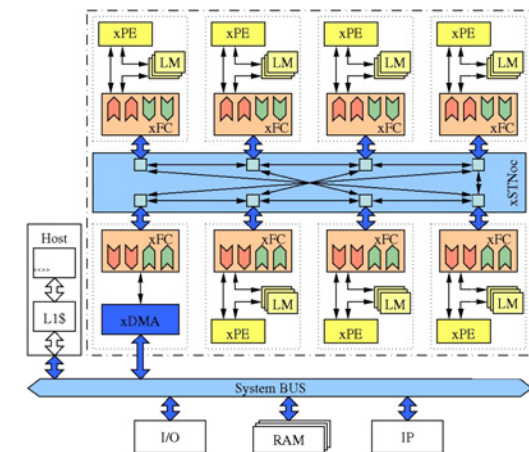

Conclusions

- Since 2000, a significant development effort for performance evaluation in CADP
 - New tool development
 - Extensions of existing tools
 - Migration: **10 architectures** (including 64-bit platforms) and **3 compilers** supported (Gcc, Sun CC, Intel CC)
- Smooth integration with functional verification
 - The Xeuca GUI
 - The SVL scripting language
- Academic and industrial applications

Future work

- Enhance integration with LOTOS NT
- Generalize techniques and tools for models containing:
 - nondeterminism
 - both stochastic and probabilistic transitions
 - non-Markov distributions, e.g., constant delays (**wait** r)
- Replace QNAP2 in Bull's performance-evaluation process

For more information...

- CADP Web site:
<http://vasy.inria.fr/cadp>
- CADP forum:
<http://cadp.forumotion.com>

